

CONTROL BOX

5.2

OPERATOR MANUAL

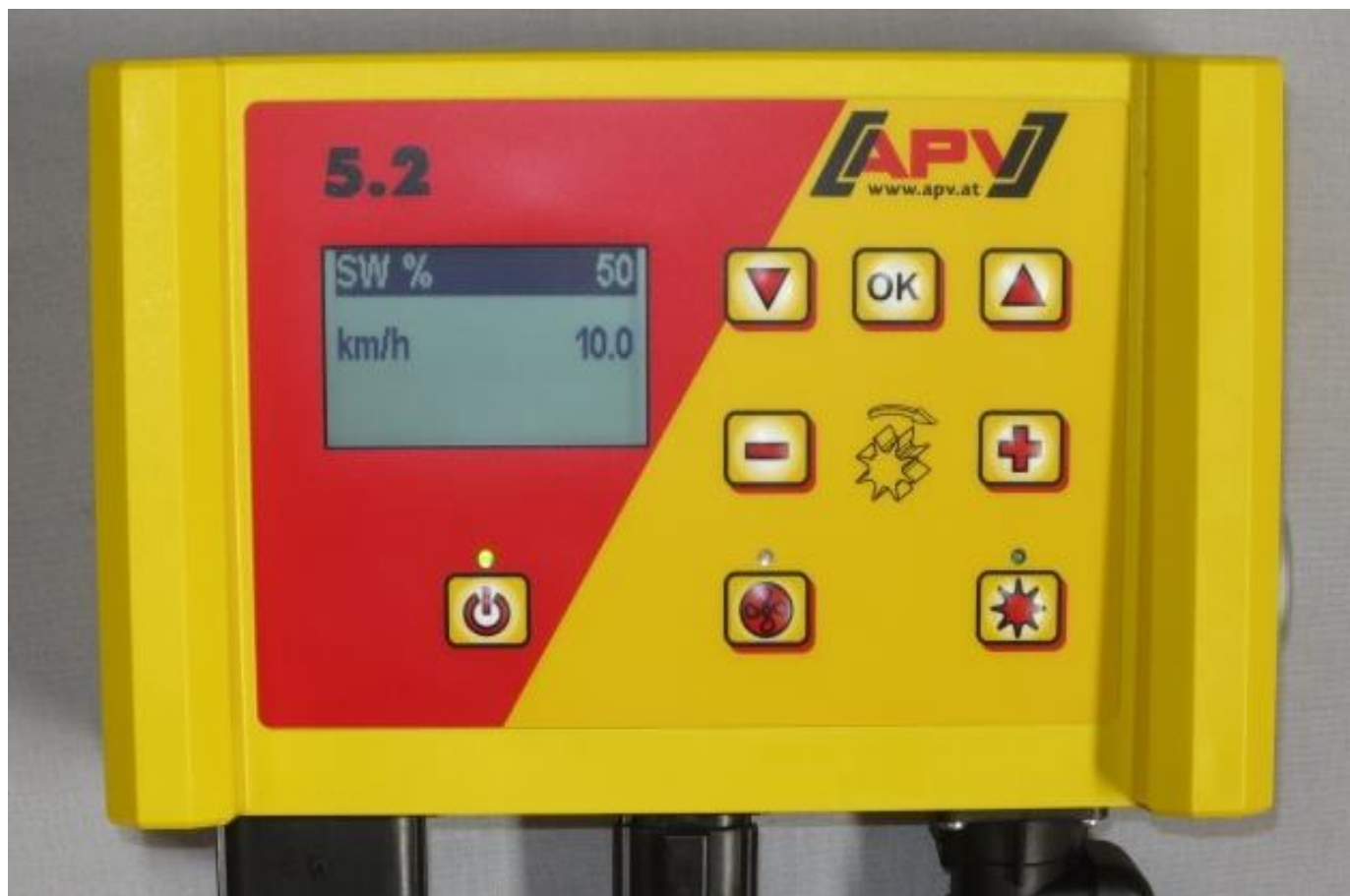

PLEASE READ CAREFULLY BEFORE COMMISSIONING!

Translation of the original operating manual

Version: 3.3 EN; item number: 00602-3-793



TABLE OF CONTENTS

1	IDENTIFICATION OF THE IMPLEMENT	4
1.1	Intended use	4
2	SERVICE	4
3	WARRANTY	4
3.1	Warranty activation	5
4	INITIAL COMMISSIONING	5
4.1	Scope of delivery and attachment	5
4.2	Electrical connection	5
4.3	Control box	7
4.4	Initial operation	8
4.4.1	Languages	8
4.4.2	Units of measure	8
4.4.3	Implement type	8
4.4.3.1	Implement type 1 (for PS)	8
4.4.3.2	Serial number (only for PS 800)	8
4.4.4	Fan	8
4.4.5	Fan monitoring	9
4.4.6	Calibration button equipped	9
4.4.7	LF pump	9
4.5	Main display	9
4.6	Selection menu	10
4.7	Initial operation of the controller without connected implement.....	10
5	FUNCTION DESCRIPTIONS	10
5.1	Calibration test (general information)	10
5.1.1	Calibrating in kg/ha	11
5.1.2	Calibrating in grains/m ²	13
5.1.3	Calibrating in grams/m ²	14
5.1.4	Calibrating according to the area and time	16
5.1.5	Calibration button	16
5.2	Changing the spread rate during operation	17
5.3	Operation with a speed sensor	17
5.3.1	Pre-seeding	18
5.3.2	Calibrating the forward speed (tachometer)	18
5.3.2.1	Test distance 100 m	18
5.3.2.2	Manual calibration	18
5.3.2.3	Calibration value	18
5.3.2.4	Calibration reset	19
5.4	Operation with linkage sensor	19
5.5	Emptying	19
5.5.1	Emptying using the calibration button	19
5.6	Operating hours counter	20
5.7	Hectare counter (seeded area)	20
5.8	Operating voltage / current display	20
5.9	Languages	20
5.9.1	Available languages:	21
5.10	Blower fan settings	21
5.11	Units of measure	22
6	CONTROLLER MESSAGES	22
6.1	Notes	22
6.2	Errors	24

7	PROBLEM SOLVING	26
8	PROGRAMMING 5.2 (CUSTOMER SERVICE)	28
8.1	Implement type	28
8.2	Fan	28
8.3	Signal when switching the seeding shaft on/off (warning tone).....	28
8.4	Ground wheel	28
8.5	Wheel sensor	29
8.6	DIN 9684 signal (7-pin signal socket).....	29
8.7	Radar sensor	29
8.8	Lifting unit sensor.....	29
8.9	Lifting unit signal	29
8.10	Buzzer (warning tone).....	30
8.11	Seeding shaft motor.....	30
8.12	Fan monitoring.....	30
8.13	Calibration button equipped	30
8.14	Units of measure.....	30
8.15	Implement type	30
8.16	Restoring the factory settings.....	31
9	ACCESSORIES	31
9.1	7-pin signal cable	31
9.2	Accessories kit for GPSa sensor MX.....	32
9.3	Accessories kit for radar sensor MX 35.....	32
9.4	Accessories kit for inductive wheel sensor MX.....	33
9.5	Accessories kit for linkage sensor chassis MX	34
9.6	Accessories kit for linkage sensor top link MX.....	35
9.7	Accessories kit for linkage sensor pull switch MX.....	35
9.8	Splitter sensor MX for power socket.....	36
9.9	Complete cable set	36
9.10	Calibration button (calibration switch).....	36
10	INDEX	38

1 IDENTIFICATION OF THE IMPLEMENT

The control box can be clearly identified based on the serial number. The serial number can be found on the rear side of the control box.



NOTE!

In cases of inquiries or warranty claims, please always tell us the serial number of your implement.

1.1 INTENDED USE

Control Box 5.2 may only be used to control Pneumatic Seeders (PS 120-1600 incl. Fertiliser Editions), Liquid Fertilizers (LF), Universal Dispensers (UDW) or Multi-Metering Systems (MDG/MDC, MDP, MDD). Please also observe the operating manual for your Pneumatic Seeder / Liquid Fertilizer / Universal Dispenser / Multi-Metering System.

Do not use Control Box 5.2 to control other implements.

2 SERVICE

Please contact our service address in the following cases:

- If you still have questions regarding the handling of this implement despite the information provided in this operating manual
- For questions regarding spare parts
- To order maintenance and repair work

Service address:

APV Technische Produkte GmbH
Zentrale: Dallein 62
A-3753 Hötzelndorf
AUSTRIA

Telephone: +43 2913 8001-5500
Fax: +43 2913 8002
Email: service@apv.at
Web: www.apv.at

3 WARRANTY

Please check the implement for any transport damage immediately upon receipt. Later claims regarding transport damage can no longer be considered.

We provide a **one-year factory warranty** as of the date of delivery (your invoice or the delivery slip serve as a warranty certificate).

This warranty is applicable for cases of material or construction faults and does not include parts that are damaged by normal or excessive wear.

The warranty expires

- if damage is caused by external forces,
- if the control box is opened,
- in cases of operating errors,
- if the prescribed requirements are not met,
- if the implement is modified, expanded or equipped with third-party spare parts without our permission,
- in cases of water ingress.

3.1 WARRANTY ACTIVATION

To be able to offer the best possible service, warranty activation must be performed for your implement after acquisition.

To activate the warranty for your implement, simply scan the QR code with your smartphone – you will then be taken directly to the warranty activation page.

You can also call up the warranty activation page through our website www.apv.at in the Service area.



4 INITIAL COMMISSIONING

4.1 SCOPE OF DELIVERY AND ATTACHMENT



1	Control box
2	Power cable
3	Controller bracket

Fasten the standard supplied bracket with two bolts in the tractor cab.

Pay attention to the angle at which you look at the control box to be able to read the display optimally. If necessary, bend the bracket slightly to adjust the angle as required.

Figure 1

CAUTION!

If possible, do not roll up the cable into a coil!

4.2 ELECTRICAL CONNECTION



Figure 2

Connect the standard supplied cable directly to the 3-pin standard socket on the tractor. The other end is connected to the control box.

The fuse (30 A) is located on the right side of the control box.

Stow the excess cable in the driver's cab to avoid pinching.

The connection diagram can be found in the operating manual for your seeder / Liquid Fertilizer / Universal Dispenser / Multi-Metering System.

CAUTION!

The 12 volt power supply must NOT be connected to the socket for the cigarette lighter!

After use of the implement and for road transport, the control box must be disconnected again (for various safety-related reasons).

CAUTION!

If these instructions are not observed, damage may be caused to the control box!

If your tractor does not have a standard socket, it can be retrofitted with a cable set (see chapter 9 Accessories).

CAUTION!

If your battery is charged by a charger that is in "Start" operating mode, there can be voltage peaks! These can cause damage to the electrical system of the control box if it is also connected when the battery is being charged!

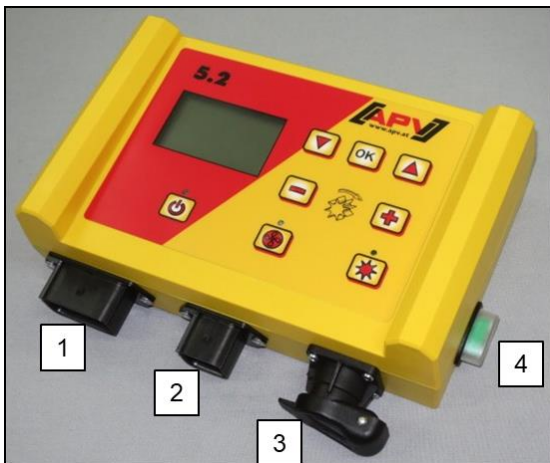

1	12-pin plug <ul style="list-style-type: none">• Ground wheel• Amphenol (for standard socket)• Linkage sensor• Wheel sensor• Radar sensor
2	6-pin plug <ul style="list-style-type: none">• Connection to the seed drill (implement cable)
3	3-pin plug <ul style="list-style-type: none">• Connection to the battery (power cable)
4	30 A fuse

Figure 3

The different types of sensors are explained in more detail in chapters 5.3 and 5.4. They are available as accessories upon customer request (see chapter 9 Accessories).

4.3 CONTROL BOX

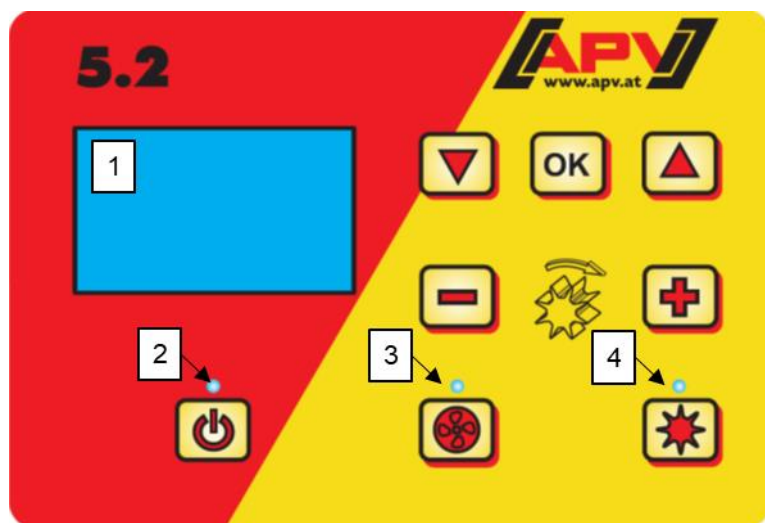

1	Graphic display
2	Lights up when the controller is switched on
3	Lights up when the fan or the spreading plate is switched on.
4	Lights up when the seeding shaft is rotating

Figure 4

Button	Designation	Function
	On/Off button	Switches the implement on and off. The control lamp lights up when the implement is switched on.
	Plus/minus buttons	Changes the speed of the seeding shaft and the respective parameters in the menu points.
	Seeding shaft On/Off button	Switches the seeding shaft on/off. When button is pressed, the seeding shaft starts rotating and the control lamp lights up.
	Arrow buttons Up arrow button (▲) Down arrow button (▼)	Navigates through the menu points.
	OK button	Confirms the selection.
	Fan button	Switches the blower fan or the spreading plate on or off. <ul style="list-style-type: none"> With electric fan/spreading plate: the control lamp flashes when the fan/spreading plate starts up. When the motor is running, the control lamp is continuously lit. With hydraulic fan (with pressure sensor): the control lamp lights up as soon as the fan has built up pressure.

4.4 INITIAL OPERATION

Explanation of the abbreviations

- SS: seeding shaft
- M: motor revolutions
- km/h: speed in kilometres per hour
- kg/ha: weight in kilograms per hectare
- l/ha: litres per hectare
- Grains/m²: grains per square metre

For the initial operation or when it was restored to factory setting in the Programming menu, the following settings must be entered on your Control Box 5.2:

4.4.1 LANGUAGES

Select your desired menu language here:

Language	Language
Langue	Язык ?
German	

Select the desired language with the plus/minus buttons and confirm with the OK button.

You can go back to the Main menu with the OK button.

4.4.2 UNITS OF MEASURE

Select metric (m, ha, km/h, kg) or imperial (ft, ac, mph, lb) measuring units.

14. Units of measure:

Use the plus/minus buttons to select **metric (kg, ha, m)** or **imperial (lb, ft, ac)** and confirm with the OK button.

4.4.3 IMPLEMENT TYPE

Here, you can select your implement type (PS, MDP, MDG/MDC, MDD, UDW, LF).

0. Implement type:

Select using the plus/minus buttons and confirm with the OK button.

4.4.3.1 IMPLEMENT TYPE 1 (FOR PS)

1. Implement type:

If you previously selected "PS" as the implement type, the system now asks which PS it is.

4.4.3.2 SERIAL NUMBER (ONLY FOR PS 800)

Here, select whether your PS 800 has a serial number higher than 01300. This will store the right motor characteristic in the control box.

S/N > 04011-01300

Select using the plus/minus buttons and confirm with the OK button.

4.4.4 FAN

Here, you must select whether an electric or hydraulic fan is installed on your PS.

1. Elec. fan equipped:

OFF: no fan equipped (for LF)

Hydraulic/external: hydraulic (or external) fan equipped

Electric: electric fan equipped

Electric PLUS: electric fan PLUS equipped

Select using the plus/minus buttons and confirm with the OK button.



Scan the QR code to view the "Initial operation of the PS" video.

4.4.5 FAN MONITORING

Here, the type of fan monitoring must be set for a hydraulic PS.

Fan monitoring:

Using the plus/minus buttons, select **PRESSURE**, **SPEED** or **NO** and confirm with the OK button.

4.4.6 CALIBRATION BUTTON EQUIPPED

Here, you can set whether a calibration button is installed on your PS (available as an accessory).

13. Calibration button equipped:

Use the plus/minus buttons to select **YES** or **NO** and confirm with the OK button.

4.4.7 LF PUMP

When selecting the implement type "LF" (Liquid Fertilizer), you must select the installed pump.

11. LF pump:

Using the plus/minus buttons, select either **EF5500 (small pump)** or **EF7000 (large pump)** and then confirm with the OK button.



The implement is being switched off!

After successfully entering this data, the control box switches itself off automatically so that the entries are saved.

Depending on the selected settings, all of the points might not be requested. However, you can also change the points as described in chapter 8 Programming 5.2 (customer service).

4.5 MAIN DISPLAY



Switch-on message: Is shown during the switch-on procedure and shows the type and device version.

This information is very helpful in the case of service and is even essential for malfunctions to be able to perform diagnosis!

PS, MDC, MDG or MDP operating mode

SS %	25.0
km/h	10.0

SS %: set speed for the seeding shaft (in %)

Must be set using the plus/minus buttons on the control box or automatically when performing the calibration test.

km/h: forward speed [km/h] defined in menu item "Calibration test".

MDD or UDW operating mode

SS %	25
km/h	10
kg/ha	20.0
Speed	2000

SS %: set speed for the seeding shaft (in %)

Must be set using the plus/minus buttons on the control box or automatically when performing the calibration test.

km/h: forward speed [km/h] defined in menu item "Calibration test".

kg/ha: current spread rate (is only displayed if a valid calibration test was performed)

LF operating mode

M %	30
km/h	10.0
l/ha	200.0

M %: set motor revolutions (in %). Must be set using the plus/minus buttons on the control box.

km/h: forward speed [km/h]

l/ha: current spread rate (only in conjunction with speed sensors)

Speed

Speed: the currently set spreading plate speed is changed on the second menu page, which can be reached by pressing the "up arrow" button (▲), using the plus/minus buttons.

4.6 SELECTION MENU

The Selection menu depends on the set implement type (see chapter 4.4.3 Implement type) After switching on the device, you can use the arrow buttons and the "OK" button to move through the menu. Each time the arrow buttons are pressed in the menu, you move one menu item up or down.

The following menu points are available:

- Main display (seeding shaft)
- Speed (only with MDD and UDW)
- Settings (only with LF; refer to the LF operating manual for more information)
- Calibration test (no calibration test with LF)
- Emptying
- Quantity (only with LF)
- Hour overview
- Area overview
- Operating voltage
- Calibrating the speed
- Fan settings (only with PS and MDP and with hydraulic PS with fan monitoring set to "Speed")
- Languages

With the OK button, you go to the respective menu points. Here, you can change the value using the plus/minus buttons.

4.7 INITIAL OPERATION OF THE CONTROLLER WITHOUT CONNECTED IMPLEMENT

The control module can also be operated for the first time without connected implement. However, the "Motor not connected (...)" error message then appears.

This error message can be suppressed for 15 sec. by pressing the OK button, then it appears again. This mainly serves for reading out the operating hours, hectare counter and various settings without having to connect the control module to the implement.

5 FUNCTION DESCRIPTIONS

5.1 CALIBRATION TEST (GENERAL INFORMATION)



NOTE!

In addition to performing a calibration test (setting of the seeding shaft speed), this menu point is also used to set the working width and the forward speed. The entered values are also used to calculate the area (seeded area).

Procedure:

Calibration test

1. Go to the **Calibration test** menu point and press the OK button.

Settings

2. In the **Settings** menu point, you can select whether you want to perform the calibration in kg/ha, grains/m² (with thousand grain weight and germination capacity) or g/m².

Calibrate in

The settings can be changed using the plus/minus buttons. By pressing the OK button or the "up arrow" button (▲), the screen goes to the next menu point.

Here, you must select one of the three variations (see chapter 5.1.1 Calibrating in kg/ha / 5.1.2 Calibrating in grains/m² / 5.1.3 Calibrating in grams/m²).

3. Select the **seeding shaft speed (%)**.
4. Select the **working width**.
5. Select the **forward speed**.
6. Select the **spread rate**.
7. Select the **calibration time** (0.5 minutes, 1 minute or 2 minutes). If you scroll further with the plus button here, you go to the selection "Calibration by area and time" (see chapter 5.1.4).

5.1.1 CALIBRATING IN KG/HA

The "Calibrating in kg/ha" instructions video can be found here (scan the QR code):



If you selected "Calibrating in kg/ha" in the Settings menu, the following points appear in the Calibration menu:

Working width?

Enter the working width here. Take note of the working width overlap.

Forward speed?

Enter the forward speed here.

kg/ha ?

Enter the desired spread rate in kg/ha here.

Calibration time?

Set the duration or the area for the calibration test here.

If a calibration button is installed and YES was entered in the Programming menu for "Calibration button equipped?", this point does not appear.



TIP:

For small seed types, e.g. canola, phacelia, poppy etc., it is best to calibrate for 2 minutes. A calibration time of 1 minute is standard.

For larger seed types, e.g. wheat, barley, peas etc., 0.5 minutes of calibration is most suitable.

**NOTE!**

Before you start the test, check whether you have removed the calibration cover and are using it or the calibration slide. Check whether the calibration bag or a collection bucket is placed precisely under the outlet! The calibration test can be aborted at any time by pressing the seeding shaft button or the fan button on the control box.

Start test ?

When all of the values are correctly set, start the test for the respective motor with OK.

Test in progress!

Calibration test in progress: After starting, the seeding shaft begins rotating automatically without the fan motor. The seeding shaft stops automatically after the set time. If a calibration button is installed, the test is only stopped once it is pressed.

Entry of the calibration test:

Now weigh the calibrated seed quantity (deduct the weight of the collection bucket or the calibration bag) and enter the weight. Confirm with OK.

To really spread the desired spread rate, we recommend repeating the calibration test until the message "Test not precise! Repeat?" no longer appears. If "Seeding shaft speed too high" appears on the display, the seeding shaft is not able to rotate fast enough. If "Seeding shaft speed too low" appears, the seeding shaft is not able to rotate slowly enough. To fix this error, you can replace the seeding shaft with a larger or smaller seeding shaft (see also chapter 6.1 Notes).

With the OK button, you can return to the previously displayed value. Only when the automatic readjustment of the seeding shaft is under 3 % (difference), the "checkmark symbol" and the spread quantity in kg/ha will appear on the main screen.

Entry of the Calibration test:

The seeding shaft speed is now automatically correctly calculated. Then the display goes back to the Main menu.

Now the set kg/ha appears on the display.

The two-column display appears when working with a speed sensor.

PS, MDC, MDG, MDP:

SS %	25.0
km/h	10.0
kg/ha	5.3

SS %	61 / 50.3
km/h	10.0 / 8.3
kg/ha	13.2

MDD, UDW:

SS %	25
km/h	10
kg/ha	20.0
Speed	2000

SS %	25 / 12.5
km/h	10.0 / 5
kg/ha	20.0
Speed	2000

LF:

M %	30
km/h	10
l/ha	200.0

M %	28 / 31
km/h	10.0 / 4.4
l/ha	200.0

If a fill level sensor is installed on your PS/MD/UDW/LF, and the message "Hopper almost empty" appears on the display during the calibration test, the test will continue running. If there is not enough seed in the hopper, however, this can falsify the precision of the calibration test.

Seeding shaft - manual

This menu point is used for rough presetting of the seeding shaft speed. The speed (%) of the seeding shaft does not need to be changed, because the settings are automatically adopted from the calibration test.



5.1.2 CALIBRATING IN GRAINS/M²

This option for the calibration test is available in the PS/MDG/MDP operating modes, **not** for MDD.

Calculation of the spread rate:

$$\text{Seeding rate (kg/ha)} = \frac{\text{Thousand grain weight TGW (g)} \times \text{grains/m}^2 \times 100}{\text{Germination capacity (\%)}}$$

If you selected "Calibrating in grains/m²" in the Settings menu, the following points appear in the Calibration menu:

Working width?	Enter the working width here. Take note of the working width overlap.
Forward speed?	Enter the forward speed here.
Grains/m²	Enter the desired grains/m ² here.
Thousand grain weight	Enter the respective thousand grain weight here.
Germination capacity	Enter the germination capacity of the seed here.
Calibration time?	Set the duration or the area for the calibration test here. If a calibration button is installed and YES was entered in the Programming menu for "Calibration button equipped?", this point does not appear.
 TIP:	For small seed types, e.g. canola, phacelia, poppy etc., it is best to calibrate for 2 minutes. A calibration time of 1 minute is standard. For larger seed types, e.g. wheat, barley, peas etc., 0.5 minutes of calibration is most suitable.
 NOTE!	Before you start the test, check whether you have removed the calibration cover and are using it or the calibration slide. Check whether the calibration bag or a collection bucket is placed precisely under the outlet! The calibration test can be aborted at any time by pressing the seeding shaft button or the fan button on the control box.
Start test ?	When all of the values are correctly set, start the test for the respective motor with OK.
Test in progress!	Calibration test in progress: After starting, the seeding shaft begins rotating automatically without the fan motor. The seeding shaft stops automatically after the set time. If a calibration button is installed, the test is only stopped once it is pressed.
Entry of the calibration test:	Now weigh the calibrated seed quantity (deduct the weight of the collection bucket or the calibration bag) and enter the weight. Confirm with OK.

To really spread the desired spread rate, we recommend repeating the calibration test until the message "Test not precise! Repeat?" no longer appears. If "Seeding shaft speed too high" appears on the display, the seeding shaft is not able to rotate fast enough. If "Seeding shaft speed too low" appears, the seeding shaft is not able to rotate slowly enough. To fix this error, you can replace the seeding shaft with a larger or smaller seeding shaft (see also chapter 6.1 Notes).

With the OK button, you can return to the previously displayed value. Only when the automatic readjustment of the seeding shaft is under 3 % (difference), the "checkmark symbol" and the spread quantity in kg/ha will appear on the main screen.

Entry of the Calibration test:

The seeding shaft speed is now automatically correctly calculated. Then the display goes back to the Main menu.

Now the set kg/ha appears on the display.

The two-column display appears when working with a speed sensor.

PS, MDC, MDP, MDG:

SS %	39.5
km/h	8.3
Grains/m2	21

SS %	48 /	39.5
km/h	10.0 /	8.3
Grains/m2		21

MDD, hydraulic PS, UDW:

SS %	25
km/h	10
Grains/m2	21
Speed	2000

SS %	25 /	12.5
km/h	10.0 /	5
Grains/m2		21
Speed		2000

LF:

M %	30
km/h	10
l/ha	200.0

M %	28 /	31
km/h	10.0 /	4.4
l/ha		200.0

PS: If a fill level sensor is installed on your PS, and the message "Hopper almost empty" appears on the display during the calibration test, the test will continue running. If there is not enough seed in the hopper, however, this can falsify the precision of the calibration test.

Seeding shaft - manual

This menu point is used for rough presetting of the seeding shaft speed. The speed (%) of the seeding shaft does not need to be changed, because the settings are automatically adopted from the calibration test.

5.1.3 CALIBRATING IN GRAMS/M²

If you selected "Calibrating in g/m²" in the Settings menu, the following points appear in the Calibration menu:

Working width?

Enter the working width here. Take note of the working width overlap.

Forward speed?

Enter the forward speed here.

g/m² ?

Enter the desired spread rate in kg/ha here.

Calibration time?

Set the duration or the area for the calibration test here. If a calibration button is installed and YES was entered in the Programming menu for "Calibration button equipped?", this point does not appear.



TIP:

For small seed types, e.g. canola, phacelia, poppy etc., it is best to calibrate for 2 minutes. A calibration time of 1 minute is standard. For larger seed types, e.g. wheat, barley, peas etc., 0.5 minutes of calibration is most suitable.



NOTE!

Before you start the test, check whether you have removed the calibration cover and are using it or the calibration slide. Check whether the calibration bag or a collection bucket is placed precisely under the outlet! The calibration test can be aborted at any time by pressing the seeding shaft button or the fan button on the control box.

Start test ?

When all of the values are correctly set, start the test for the respective motor with OK.

Test in progress!

Calibration test in progress: After starting, the seeding shaft begins rotating automatically without the fan motor. The seeding shaft stops automatically after the set time. If a calibration button is installed, the test is only stopped once it is pressed.

Entry of the calibration test:

Now weigh the calibrated seed quantity (deduct the weight of the collection bucket or the calibration bag) and enter the weight. Confirm with OK.

To really spread the desired spread rate, we recommend repeating the calibration test until the message "Test not precise! Repeat?" no longer appears. If "Seeding shaft speed too high" appears on the display, the seeding shaft is not able to rotate fast enough. If "Seeding shaft speed too low" appears, the seeding shaft is not able to rotate slowly enough. To fix this error, you can replace the seeding shaft with a larger or smaller seeding shaft (see also chapter 6.1 Notes).

With the OK button, you can return to the previously displayed value. Only when the automatic readjustment of the seeding shaft is under 3 % (difference), the "checkmark symbol" and the spread quantity in kg/ha will appear on the main screen.

Entry of the Calibration test:

The seeding shaft speed is now automatically correctly calculated. Then the display goes back to the Main menu.

Now the set kg/ha appears on the display.

PS, MDC, MDP, MDG:

SS %	100
km/h	10.0
g/m2	20.0

The two-column display appears when working with a speed sensor.

SS %	20 / 20.1
km/h	10.0 / 10.1
g/m2	20.00

MDD, hydraulic PS, UDW:

SS %	100
km/h	10.0
g/m2	20.0

SS %	20 / 20.1
km/h	10.0 / 10.1
g/m2	20.00

PS: If a fill level sensor is installed on your PS, and the message "Hopper almost empty" appears on the display during the calibration test, the test will continue running. If there is not enough seed in the hopper, however, this can falsify the precision of the calibration test.

Seeding shaft - manual

This menu point is used for rough presetting of the seeding shaft speed. The speed (%) of the seeding shaft does not need to be changed, because the settings are automatically adopted from the calibration test.

5.1.4 CALIBRATING ACCORDING TO THE AREA AND TIME

After you have selected one of the three variations (chapter 5.1.1 Calibrating in kg/ha / 5.1.2 Calibrating in grains/m² / 5.1.3 Calibrating in grams/m²), you can choose between 3 preset areas (1/10 ha, 1/20 ha and 1/40 ha) for the calibration time. In addition to the area, the calibration time in seconds is also shown depending on the preset working width and forward speed.

Calibration time? 1/40 ha (30 s)	Calibration time? 1/20 ha (60 s)	Calibration time? 1/10 ha (120 s)
--	--	---

The rest of the procedure for the calibration test is the same as in chapters 5.1.1 – 5.1.3.

5.1.5 CALIBRATION BUTTON



If a calibration button is installed on your implement, and it is set to YES in the Programming menu (see chapter 8), the "Calibration time" menu point is not shown. Enter the desired settings. Then press on "Start test". The following screen is then shown on the display and the system waits until the calibration button is pressed.

The seeding shaft rotates until the calibration button is deactivated. The control box calculates the target rate based on the calibration time, and shows it on the display. Now weigh the calibrated quantity and enter it on the control box. If necessary, repeat the procedure to obtain more precise settings.



NOTE!

To achieve sufficient accuracy, the calibration button must be pressed and held for at least 20 seconds; otherwise, the notification message "Calibration time too short!" appears and the kg/ha, grains/m² or g/m² are not shown on the main display.

If the calibration button is activated, it can also be used to empty the hopper.

5.2 CHANGING THE SPREAD RATE DURING OPERATION

PS, MDP, MDG:

SS %	61 /	50.3
km/h	10.0 /	8.3
kg/ha	+10%	13.2

MDD, UDW:

SS %	25 /	50.3
km/h	10 /	8.3
kg/ha	+10%	20.0
Speed		2000

LF:

M %		37
km/h	10.0 /	4.4
l/ha	+15%	230

By pressing the plus/minus buttons – as soon as a successful calibration test was performed – the spread rate is increased or reduced by 5%. Every time the plus button is pressed, the spread rate increases by 5% of the entered spread rate, and when the minus button is pressed, the spread rate is reduced in 5% increments. The spread rate can be increased or reduced by a maximum of 50%.

If there is no (successful) calibration test, the seeding shaft speed is increased or reduced in 1% increments by pressing the plus/minus button.

By pressing the plus/minus buttons on the Main screen, the preset spread rate can be changed in 5%-increments to a maximum of +/- 50%. The change is shown on the Work screen.

5.3 OPERATION WITH A SPEED SENSOR

When working with a speed sensor, the display looks as follows:

PS, MDP, MDG:		
TARGET value	ACTUAL value	
SS %	50 /	25.0
km/h	20.0 /	10.0

MDD, UDW:		
TARGET value	ACTUAL value	
SS %	25 /	12.5
km/h	10 /	5
kg/ha		20.0
Speed		2000

LF:		
TARGET value	ACTUAL value	
M %	28 /	31
km/h	10.0 /	4.4
l/ha		200.0

	TARGET value	ACTUAL value
SS % (seeding shaft)	Set speed of the seeding shaft (in %). Setting using the plus/minus buttons on the main screen of the control box or by performing a calibration test.	Actual speed of the seeding shaft (in %). Is calculated and displayed by the control box depending on the forward speed.
M % (motor revolutions)	Set motor revolutions (in %). Setting using the plus/minus buttons on the main screen of the control box.	Actual motor revolutions (in %).
km/h (forward speed)	Is set in the "Calibration test" menu point.	Actual forward speed in km/h. Is measured by the sensor and shown on the control box.

5.3.1 PRE-SEEDING

When the OK button is pressed and held for 1 second, the seeding shaft starts rotating at the speed determined by the calibration test as long as the OK button remains pressed. This allows you to avoid gaps in the seeded area (at the beginning of the field or when standing still on the field). As soon as the button is released again, the control box works with the signals from the respective speed sensor again. When working with a linkage sensor, the soil tillage implement must be "in working position".

5.3.2 CALIBRATING THE FORWARD SPEED (TACHOMETER)

The calibration should be performed because the control box uses this value as a basis for all calculations (speed display, metering, area calculation).

There are 3 options for the calibration:

5.3.2.1 TEST DISTANCE 100 M

Calibrate the speed?	> OK >	Test distance 100 m?	> OK
Drive 100 m => START?	> OK		
=> STOP		Drive a distance of exactly 100 m. While driving, the control box counts the pulses for the travelled distance on the display. Stop with the OK button after 100 m.	
Speed is calibrated!		Appears when the calibration is finished.	



TIP!
The maximum values for the wheel sensor are 1500 pulses per 100 m, all other sensors have 51200 pulses per 100 m.

5.3.2.2 MANUAL CALIBRATION

Manual?	> OK >	Manual? 13 km/h 125%	> OK
---------	--------	-------------------------	------

While driving, compare the speed on the display to the speed of the tractor tachometer. Use the plus/minus buttons to correct the value until they are equal.



TIP!
This calibration can be performed manually, without driving the 100 m test distance.



NOTE!
The calibration is only truly accurate when a radar or GPS sensor is installed on your tractor. Otherwise, the slippage is not included in the forward speed!

5.3.2.3 CALIBRATION VALUE

Calibration value?	Here, the pulses/100 m can be set manually.
--------------------	---



TIP!
If you have calibrated your implement before, take note of the value and set it here again if necessary.

5.3.2.4 CALIBRATION RESET

Calibration
area calc.?

Confirm with the OK button.
Resets the value back to the factory setting.

Calibration
reset

Appears after the calibration has been successfully reset.

5.4 OPERATION WITH LINKAGE SENSOR

With a linkage sensor, the seeding shaft of the PS can start and stop rotating automatically when lifting and lowering the implement. As a result, you don't need to switch the seeding shaft on/off manually at the headlands.

There are 4 types of linkage sensors:

- 7-pin signal cable (see chapter 9.1)
- Linkage sensor chassis (see chapter 9.5)
- Linkage sensor top link (see chapter 9.6)
- Linkage sensor pull switch (see chapter 9.7)

By pressing and holding the seeding shaft button for 2 seconds, the seeding shaft can be switched on regardless of the position of the linkage sensor. This only works when working without a speed sensor.



NOTE!

The warning tone that is emitted when switching the seeding shaft on/off can be deactivated as described in chapter 8.10.

5.5 EMPTYING

Emptying

This menu point is for practical emptying of the hopper (e.g. when finishing work, changing seeds, changing the seeding shaft).

Emptying in progress!

The motor is running at maximum speed (without fan).

Emptying can be stopped at any time by pressing the plus/minus, seeding shaft or fan buttons. Then the display goes back to the Main menu.



TIP!

Before you start emptying, check whether you have removed the calibration cover and are using it or the calibration slide. Check whether the calibration bag or a collection bucket is placed precisely under the outlet.

5.5.1 EMPTYING USING THE CALIBRATION BUTTON



If you have a calibration button installed on your implement and it is set to YES in the Programming menu (see chapter 0), it can then be used to empty the hopper. The seeding shaft rotates at maximum speed as long as the calibration button is pressed.

5.6 OPERATING HOURS COUNTER

Total hours:

23.46 h

Hours:

0.38 h

Operating hours counter = running time of the seeding shaft.

Shows the total hours and the daily hours.

By pressing the OK button (press and hold for 5 seconds), the daily hours can be reset to zero. The total hours cannot be reset to zero.

5.7 HECTARE COUNTER (SEEDED AREA)

Total area:

12.07 ha

Area:

3.93 ha

Shows the total seeded area in hectares.

The values are automatically set when the calibration test is performed. The area that is seeded is only counted when the seeding shaft starts rotating.

By pressing the OK button (press and hold for 5 seconds), the area can be reset to zero. The total area cannot be reset to zero.

5.8 OPERATING VOLTAGE / CURRENT DISPLAY

Operating voltage

11.7 V

I-1: I-2:

12.6A 1.2 A

Shows the current operating voltage.

If this value starts fluctuating strongly during operation, there are problems with your on-board electronics. This can lead to poor spreading results!

I-1: Shows the current consumption of the fan motor (for PS, MDP, MDG) or spreading plate motor (for MDD, UDW) in amperes.

I-2: Shows the current consumption of the electric seeding shaft motor or pump (for LF) in amperes.

5.9 LANGUAGES

Select your desired menu language here:

Language Language

Langue Язык ?

German

Select the desired language with the plus/minus buttons and confirm with the OK button.

You can go back to the Main menu with the OK button.

5.9.1 AVAILABLE LANGUAGES:

As of software version V1.28, the following languages are available for selection:

- German (Deutsch)
- English
- French (Français)
- Dutch (Nederlands)
- Danish (Dansk)
- Polish (Polski)
- Italian (Italiano)
- Spanish (Español)
- Czech (Česky)
- Hungarian (Magyar)
- Finnish (Suomi)
- Portuguese (Português)
- Rumanian (Romana)
- Swedish (Svenska)
- Estonian (Eesti)
- Latvian (Latvijas)
- Lithuanian (Lietuvos)
- Norwegian (Norske)
- Slovenian (Slovenski)
- Russian (Русский)
- Serbian (Srpski)
- Turkish (Türkçe)
- Croatian (Hrvatski)
- Chinese (中文)
- Japanese (ニホンゴ)

5.10 BLOWER FAN SETTINGS

In this menu point, the rotational speed of the electric fan and therefore also the air output can be set. This can be helpful when working with very fine (light) seeds (e.g.: micropellets, canola,...) or if air separators are installed. Moreover, the current consumption of the fan can be reduced if the full air output is not required for operation.

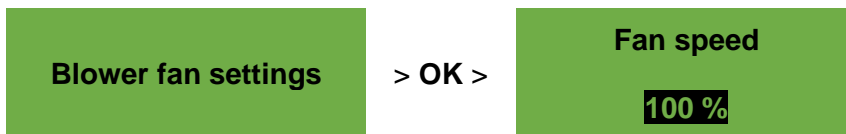

NOTE!

This display only appears if you are in PS or MDP operating mode and you are working with an electric fan.

Correct the fan speed in 1% increments using the plus/minus buttons until the desired fan speed is set. (Adjustments in 1% increments is only possible above 20%.)

If a hydraulic fan is being used and "Speed" is selected for the fan monitoring (menu point 12), the following setting options are possible under the fan settings menu point:

Fan speed min. Here, the lower limit is set for the speed. If this limit is undercut, the error message "Speed too low (fan)!" is shown.

Fan speed max. Here, the upper limit is set for the speed. If this limit is exceeded, the notification message "Speed too high (fan)!" is shown.

Use the plus/minus buttons to correct the value (in increments of 100) until the limit values are set.

Pulses per revolution Here, you can set the number of pulses per revolution. The default value is 5 and it can be changed in increments of 1 from 1-10 using the plus/minus buttons.

5.11 UNITS OF MEASURE



NOTE!







This menu point can only be called up during initial operation (see chapter 4.4) or through the Programming menu (see chapter 8).









14. Units of measure:

The units of measure for length, area, weight and forward speed can be switched between the metric units (m, ha, kg, km/h) and imperial units (ft, ac, lb, mph).

6 CONTROLLER MESSAGES

6.1 NOTES



Display	Cause	Solutions
 Internal VCC (5 V) not OK!	The internal control voltage is below a minimum value.	➤ Send the control box back to the factory.
 Low operating voltage!	The operating voltage is too low. The operating voltage must be above 10 V (see chapter 5.8).	<ul style="list-style-type: none"> ➤ Minimise the consumers. ➤ Check the battery. ➤ Check the cabling. ➤ Check the alternator.
 High operating voltage!	The operating voltage is too high.	➤ Check the alternator.
 Hopper almost empty	The fill level sensor is no longer covered with seed (for longer than 30 seconds).	<ul style="list-style-type: none"> ➤ Refill seed. ➤ The sensor may need to be readjusted (rotated further down).
 Calibration value too high!	The number of pulses during calibration is too high.	<ul style="list-style-type: none"> ➤ When calibrating the speed, reduce the number of magnets on the wheel sensor. ➤ Install the sensor on the shaft rotating more slowly.
 Calibration value too low!	The number of pulses during calibration is too low.	<ul style="list-style-type: none"> ➤ When calibrating the speed, increase the number of magnets on the wheel sensor. ➤ Check the sensor. ➤ Check the cabling. ➤ Check the settings for the speed sensor.
 Seeding shaft speed too low!	The seeding shaft speed during the calibration test is too low.	<ul style="list-style-type: none"> ➤ Use a seeding shaft with smaller/finer or fewer seed wheels. ➤ Increase the forward speed. ➤ Increase the spread rate.

Display	Cause	Solutions
	During field operation, the PS is equipped with several implement extension cables, and it may not be possible to achieve the higher seeding shaft speeds that may be required.	<ul style="list-style-type: none"> ➤ Reduce the number of implement extension cables to a minimum. ➤ Check the battery and plug connections. ➤ Use a seeding shaft with larger/coarser seed wheels.
 Seeding shaft speed too high!	The seeding shaft speed during the calibration test is too high.	<ul style="list-style-type: none"> ➤ Use a seeding shaft with larger/coarser or multiple seed wheels. ➤ Reduce the forward speed. ➤ Reduce the spread rate.
 Speed too low (pump)!	<ul style="list-style-type: none"> • The pump is running at its maximum and can no longer reach the spread rate. • The flow sensor connection (brown, black) is not or not properly connected. 	<ul style="list-style-type: none"> ➤ Reduce speed. ➤ Reduce the spread rate. ➤ Use larger nozzles. ➤ Install more outlets. ➤ Check the cabling.
 Calibration time too short!	The calibration time is too short.	<ul style="list-style-type: none"> ➤ To achieve sufficient accuracy, the calibration button must be pressed and held for at least 20 seconds.
 Vehicle speed too high!	The forward speed is too high and the seeding shaft can no longer readjust.	<ul style="list-style-type: none"> ➤ Reduce the forward speed. ➤ Use a coarser seeding shaft.
 Vehicle speed too low!	The forward speed is too low and the seeding shaft can no longer readjust.	<ul style="list-style-type: none"> ➤ Increase the forward speed. ➤ Use a finer seeding shaft.
 Searching for GPS signal Maintain speed (10.00 km/h)!	There is no GPS signal and the seeding shaft is switched on.	<ul style="list-style-type: none"> ➤ Maintain the prescribed forward speed. The forward speed that was selected for the previously performed calibration test is always shown.
 Searching for GPS signal!	There is no GPS signal.	
 The implement is being switched off!	Is displayed during the shutdown process.	<ul style="list-style-type: none"> ➤ The message disappears after a few seconds.
 Speed too high (fan)!	<ul style="list-style-type: none"> • The speed of the hydraulic fan is higher than the upper limit (set in Point 5.10). • The pulses/revolution parameter is incorrectly set. 	<ul style="list-style-type: none"> ➤ Reduce the speed of the hydraulic fan. ➤ Set the pulses/revolution parameter correctly, see Point 5.10.

6.2 ERRORS

Display	Cause	Solutions
(X) Operating voltage not OK!	The operating voltage is falling below a minimum value or large voltage fluctuations are occurring.	<ul style="list-style-type: none"> ➤ Check the cabling and plugs. ➤ Check the battery. ➤ Check the alternator. ➤ Switch off other consumers (e.g. work floodlights).
(X) Motor overloaded (seeding shaft)!	<ul style="list-style-type: none"> • The seeding shaft is not able to rotate. • The motor is being strained too long at its limits. 	<ul style="list-style-type: none"> ➤ Switch off the control box! ➤ Check if solid substances or similar are preventing the seeding shaft or agitator from turning or impeding their operation. ➤ With seed that flows well, the agitator can also be switched off. ➤ Remove 1-3 spacing discs from the seeding shaft. ➤ Check the set motor type. ➤ Check the motor for proper function while it is idling (switch off the control box, remove the motor, switch on the control box, switch on the seeding shaft motor).
(X) Motor overloaded (fan)!	The electric fan is being strained too long at its limits.	<ul style="list-style-type: none"> ➤ Switch off the implement and check if there are objects blocking the fan or preventing it from rotating properly. ➤ Check whether the calibration cover is installed, and if all of the seeding hoses are connected.
(X) Motor overloaded (spreading plate)!	<ul style="list-style-type: none"> • The spreading plate is not able to rotate. • The motor is being strained too long at its limits. 	<ul style="list-style-type: none"> ➤ Switch off the implement and check if there are foreign objects or similar that prevent the spreading disc from rotating properly.
(X) Motor not connected (seeding shaft)!	The cables are not or not properly connected.	<ul style="list-style-type: none"> ➤ Check the cables and plugs.
(X) Motor not connected (fan)!	The cables are not or not properly connected.	<ul style="list-style-type: none"> ➤ Check the cables and plugs. ➤ When using a hydraulic fan: see chapter 8.2.
(X) Motor not connected (spreading plate)!	The cables are not or not properly connected.	<ul style="list-style-type: none"> ➤ Check the cables and plugs.

Display	Cause	Solutions
(X) Motor not connected (pump)!	The pump is not or not properly connected. The pump's safety switch is being triggered by overpressure in the system.	<ul style="list-style-type: none"> ➤ Check the cabling. ➤ Open the valves all the way. ➤ Reduce pressure in the system: larger nozzles, more outlets. ➤ Check for blockages and eliminate them if necessary.
(X) Error (fan)!	Hydraulic: <ul style="list-style-type: none"> • The hydraulic fan is not producing an air current. • The return pressure in the tank line of the hydraulic fan motor is too high. 	<ul style="list-style-type: none"> ➤ Switch on the hydraulic fan and wait until the LED lights up. Then switch on the seeding shaft. ➤ Check the fastening and the cables for the fan speed sensor. ➤ Replace the return line filter. ➤ Do not use a reduction for the tank line (e.g. BG 3 coupling). ➤ Use a larger tank line.
	Electric fan PLUS: <ul style="list-style-type: none"> • E01: Fan overload • E02: Fan not connected 	<ul style="list-style-type: none"> ➤ Switch off the implement and check if there are objects blocking the fan or preventing it from rotating properly. ➤ Check the cables and plugs for damage.
(X) No motor speed (seeding shaft)!	The motor is connected and not overloaded, but still does not rotate.	<ul style="list-style-type: none"> ➤ Restart the Control Box. ➤ Check the clamp connections on the spreader. ➤ Contact customer service.
(X) No motor speed (fan)!	The motor is connected and not overloaded, but still does not rotate.	<ul style="list-style-type: none"> ➤ Restart the Control Box. ➤ Check the clamp connections on the spreader. ➤ Contact customer service.
(X) No motor speed (spreading plate)!	The motor is connected and not overloaded, but still does not rotate.	<ul style="list-style-type: none"> ➤ Restart the Control Box. ➤ Contact customer service.
(X) No motor speed (pump)!	<ul style="list-style-type: none"> • The flow sensor connection (blue) is not or not properly connected. • The pump is running at its minimum and cannot reach the spread rate. 	<ul style="list-style-type: none"> ➤ Restart the Control Box. ➤ Check the cabling. ➤ Reduce speed. ➤ Increase the spread rate. ➤ Smaller nozzles. ➤ Fewer outlets.
(X) Ground wheel not OK!	The control box is not receiving any signals from the speed sensor.	<ul style="list-style-type: none"> ➤ Check the ground wheel, sensor, cables and plugs. ➤ If a defects cannot be found on the ground wheel that explain the malfunction, please contact customer service.

Display	Cause	Solutions
 Speed too low (fan)!	<ul style="list-style-type: none"> The speed of the hydraulic fan is below the lower limit (set in Point 5.10). The pulses/revolution parameter is incorrectly set. 	<ul style="list-style-type: none"> Switch on the hydraulic fan. Increase the speed of the hydraulic fan. Set the pulses/revolution parameter correctly, see Point 5.10. A speed sensor is not installed on the fan, see Point 4.4.5.
 Short circuit on the sensor lines!	<ul style="list-style-type: none"> The sensor supply lines are overloaded. A short circuit occurred. 	<ul style="list-style-type: none"> Check the cables for damage and short circuits.





7 PROBLEM SOLVING

Problem	Cause	Solutions
Seeding shaft rotates when the implement is lifted.	<ul style="list-style-type: none"> Wrong linkage signal. 	<ul style="list-style-type: none"> Invert the tractor linkage signal, see chapter 8.9. Reposition the linkage sensor.
Seeding shaft does not rotate when the implement is in working position.	<ul style="list-style-type: none"> Seeding shaft is not switched on. Forward speed is zero. No linkage signal. 	<ul style="list-style-type: none"> Switch on the seeding shaft. The seeding shaft must be switched on manually one time at the beginning. Check the settings for the speed sensor, see chapters 8.4 – 8.7. Check the speed sensor. Check the linkage sensor.
The fill level sensor is installed, but is not transmitting.	<ul style="list-style-type: none"> No signal from the fill level sensor. 	<ul style="list-style-type: none"> Adjust the sensitivity of the fill level sensor (screw on the rear side). Reposition the fill level sensor. Check the plug and cable.
Fill level sensor is constantly transmitting.	<ul style="list-style-type: none"> Poor sensor setting. Poor sensor position. 	<ul style="list-style-type: none"> Adjust the sensitivity of the fill level sensor (screw on the rear side). Reposition the fill level sensor.
No speed signal.	<ul style="list-style-type: none"> Speed sensor was not detected. Incorrect speed sensor selected. Y cable (splitter cable) incorrectly connected. Y cable (splitter cable) defective. 	<ul style="list-style-type: none"> Check the settings for the speed sensor, see chapters 8.4 – 8.7. Connect the Y cable properly, pay attention to the markings/labels. Test without the Y cable (only connect the speed sensor).

Problem	Cause	Solutions
No linkage signal.	<ul style="list-style-type: none"> • Linkage sensor is not detected. • There is no linkage signal emitted on the 7-pin signal plug of the tractor. • Y cable (splitter cable) incorrectly connected. • Y cable (splitter cable) defective. • Magnet sensor: sensor/magnet incorrectly installed. 	<ul style="list-style-type: none"> ➤ Check the linkage sensor. ➤ Connect the Y cable properly, pay attention to the markings/labels. ➤ Test without the Y cable (only connect the linkage sensor). ➤ Magnet sensor: the sensor and magnet must be precisely opposite to each other when in working position or in lifted position.
The control box cannot be switched on.	<ul style="list-style-type: none"> • Power cable is not properly connected. • No supply voltage. • Defective fuse. 	<ul style="list-style-type: none"> ➤ Check the plugs. ➤ Check the polarity of the power cable (pin 15/30 12 V +, pin 31 ground, pin 82 ignition on +). ➤ Switch on the ignition. ➤ Check the battery. ➤ Replace the fuse.
The control box is switched off when the motors are switched on.	<ul style="list-style-type: none"> • Battery is weak, supply voltage collapses. • Voltage drop due to poor contact. 	<ul style="list-style-type: none"> ➤ Check the battery voltage. ➤ Check the contacts of the plugs. ➤ Check the power supply cable.
A forward speed of 0.0 km/h is displayed or it keeps jumping back to 0.0 km/h.	<ul style="list-style-type: none"> • Wrong speed signal detected or selected. 	<ul style="list-style-type: none"> ➤ Check the speed sensor settings, see chapter 8.4 – 8.7. If all of the settings are on AUTO, then set the first DIN 9684-1 signal to NO.
Spread rate in kg/ha or grains/m ² is not being displayed.	<ul style="list-style-type: none"> • A valid calibration test was not performed. • Value was retroactively changed in the Calibration test menu. 	<ul style="list-style-type: none"> ➤ Perform a calibration test.
Spread rate is too high or too low.	<ul style="list-style-type: none"> • Wrong speed. • Linkage sensor switches during operation. • Seed properties have changed. 	<ul style="list-style-type: none"> ➤ Check the hectare counter and speed. ➤ Calibrate the speed sensor (not required for GPSa sensor). ➤ Check the linkage sensor. ➤ Perform a calibration test. ➤ Reduce the fan speed for the hydraulic fan.
Return pressure is too high (fan error message).	<ul style="list-style-type: none"> • Line cross-section is too small. • Line is too long. • Return line filter is clogged. • Constriction in a hydraulic coupling. 	<ul style="list-style-type: none"> ➤ Use a larger line cross-section. ➤ Use a new return line filter. ➤ Use a larger hydraulic coupling.

8 PROGRAMMING 5.2 (CUSTOMER SERVICE)

To call up the Programming menu, press and hold the On/Off button for approx. 5 seconds. You can scroll through the Programming menu by pressing the arrow buttons. The parameters can be changed by pressing the plus/minus buttons.

Button	Designation	Function
	On/Off button	Switching the Control Box on/off and calling up the Programming menu.
	Arrow buttons Up arrow button (▲) Down arrow button (▼)	Scrolling in the programming menu.
	Plus/minus buttons	Changing the parameter.
	OK button	Finishing and confirming the programming.



NOTE!

If a value was changed in the programming menu and you exit the programming menu, the control box switches itself off automatically. You must then start the control box to accept the changed settings.

When it is set to AUTO, the control box automatically detects which sensor is connected and sending signals.

8.1 IMPLEMENT TYPE

0. Implement type

Select the implement type for which you want to enter the settings: PS, MDP, MDG/MDC, MDD, UDW, LF

8.2 FAN

1. Elec. fan equipped:

This menu point is used to select the fan. The following fan types can be set.

Use the plus/minus buttons to select whether:

- OFF
- Hydraulic/external
- Electric
- Electric PLUS

8.3 SIGNAL WHEN SWITCHING THE SEEDING SHAFT ON/OFF (WARNING TONE)

2. Signal when switching the seeding shaft on/off:

The acoustic warning tone when switching the seeding shaft on/off can be activated or deactivated here.

Use the plus/minus buttons to select YES/NO.

8.4 GROUND WHEEL

3. Ground wheel equipped:

In this menu point, you can select whether you are working with or without a ground wheel.

Use the plus/minus buttons to select YES/NO.

8.5 WHEEL SENSOR

4. Speed sensor on the tractor wheel equip.:

Here, you can select whether you are working with the speed sensor on the tractor or the feeler wheel.

Use the plus/minus buttons to select **YES/NO**.

8.6 DIN 9684 SIGNAL (7-PIN SIGNAL SOCKET)

Here, you can select whether you are using signals from the tractor and which ones.

Provided that they are equipped, 3 different signals are used:

- Linkage signal (not equipped on all tractors)
- Theoretical speed (from the gearbox)
- Actual speed (usually from the radar sensor)



TIP: If several speed signals are available, the (more accurate) actual speed signal is preferred.

5. DIN signal "Cur. speed" equipped:

Here, you can set whether an actual speed signal is available (PIN 1 on the 7-pin signal socket).

Use the plus/minus buttons to select **YES/NO**.

6. DIN signal "Theor. speed" equipped:

Here, you can set whether a theoretical speed signal is available (PIN 2 on the 7-pin signal socket).

Use the plus/minus buttons to select **YES/NO**.

8.7 RADAR SENSOR

7. Radar sensor equipped:

Here, you can select whether you are working with or without a radar sensor (or GPSa).

Use the plus/minus buttons to select **YES/NO**.

8.8 LIFTING UNIT SENSOR

8. Linkage equipped:

If you want to work with the linkage signals from the tractor or a linkage sensor, please select:

Use the plus/minus buttons to select **YES/NO/AUTO/2 sections**.

8.9 LIFTING UNIT SIGNAL

9. Signal level "Linkage in working position":

If you are working with the linkage signal from the tractor or the linkage sensor, here you can set the position of the linkage sensor. The position of the sensor can be inverted here and therefore adjusted to the conditions.

Use the plus/minus buttons to select **HI** or **LO**.



NOTE!

If you PS would, for example, seed with the wrong linkage position, this can be changed here.

8.10 BUZZER (WARNING TONE)

10. Buzzer:

In this menu point, you can set whether you want to work with an acoustic buzzer (e.g. warning signal in case of error messages) or without this aid. Use the plus/minus buttons to select **ON** or **OFF**.

8.11 SEEDING SHAFT MOTOR

11. Motor Seeding shaft:

Here, the gear motor to be controlled can be set.

Use the plus/minus buttons to select either

P8 motor (installed on PS 120-500 and all MDP, MDG/MDC, MDD, UDW)

P16 motor (installed on PS 800 up to serial number 04001-01299)

P17 motor (installed on PS 800 as of serial numbers higher than 04011-01300 and PS 1600)



NOTE!

If you have selected the LF (Liquid Fertilizer) as the implement type, you can choose between the two pumps here under "11. LF pump". Use the plus/minus buttons to select either EF5500 (small pump) or EF7000 (large pump).

8.12 FAN MONITORING

12. Fan monitoring equipped?

Here, you must set whether and which fan monitoring is equipped on your PS.

Using the plus/minus buttons, select **NO**, **PRESSURE** or **SPEED**.

8.13 CALIBRATION BUTTON EQUIPPED

13. Calibration switch equipped:

Here, you can set whether a calibration switch (calibration button) is installed on your implement.

Use the plus/minus buttons to select **YES** or **NO**.

8.14 UNITS OF MEASURE

14. Units of measure:

Here, you can switch from metric (m, ha, km/h, kg) units to imperial (ft, ac, mph, lb) units.

Use the plus/minus buttons to select **Metric** or **Imperial**.



NOTE!

If the language is set to Chinese, there is only the option of setting the units to "mu".

8.15 IMPLEMENT TYPE

15. Implement type query when switching on?

Here, you can set whether the control box should request the used implement type (PS, MDP, MDG/MDC, MDS, UWD, LF) every time the control box is switched on.

Use the plus/minus buttons to select **YES** or **NO**.



TIP!

If you are using the same controller to operate several different types, you therefore do not need to enter the Programming menu every time to change the type.

8.16 RESTORING THE FACTORY SETTINGS

Restore the factory settings?

Here, you can restore the factory settings.

Press the OK button.

Using the plus/minus buttons, select **YES** and then press the OK button again.

The set language, the total hours and the total areas are kept in the process.

9 ACCESSORIES

The following accessories can be ordered for Control Box 5.2:

9.1 7-PIN SIGNAL CABLE

With the 7-pin signal cable, a connection from the tractor to the control box can be established. In this case, the control box receives 3 signals from the tractor (DIN 9684 standard). The forward speed [km/h] and the linkage signal (working position) will then be transmitted from the tractor to the control box. It is shown on the control box. The seed quantity is now automatically regulated by regulating the speed of the seeding shaft. As a result, the desired seed quantity per hectare is always maintained, even if the driven speed deviates slightly from the defined speed.

The control box takes care of all procedures for the operator, such as the controlling during the working process. Thanks to the lifting unit signal, no manual operation on the control box is required when turning. On some tractors, the lifting unit signal is inverted. If the seeding shaft rotates as soon as the linkage is lifted out, then proceed as described under section 8.6.



Figure 5

Order number: 00410-2-155
Cable length: 1.5 m
Connection: 12-pin plug on the control box
Settings: see chapter 8.6



NOTE!

The signal socket is not completely assigned by all tractor manufacturers, even if it is installed in the cab.

9.2 ACCESSORIES KIT FOR GPSA SENSOR MX

The GPSa sensor transmits the current vehicle speed to the control box. The current speed is measured through the combination of a GPS and a 3D acceleration sensor. As a result, the sensor reacts extremely rapidly to changes in speed. Moreover, the sensor must only be mounted horizontally on the implement (with the arrow in the direction of travel).

Order number: 00410-2-180
Cable length: 5 m
Connection: 12-pin plug on the control box
Scope of delivery: 1 GPSa sensor, data sheet, mounting plate incl. mounting material



Figure 6



NOTE!

Calibration is NOT necessary!



NOTE!

The sensor does not function if there is complete GPS shadowing.

9.3 ACCESSORIES KIT FOR RADAR SENSOR MX 35

The radar sensor measures the forward speed [km/h]. This is displayed on the control box and the seed quantity is automatically regulated by regulating the speed of the seeding shaft. As a result, the desired seed quantity per hectare is always maintained, even if the driven speed deviates slightly from the speed defined by the calibration test.

The radar sensor works on almost any substrate (e.g. soil, sand, pavement, etc.). There may be imprecision if there is of snow or thick layers of ice, or when the on-board voltage drops below 9 V.

Order number: 00410-2-179
Connection: 1-pin plug on the control box
Scope of delivery: 1 radar sensor, 1 mounting plate, incl. fastening material

Settings: see Point Chapter 8.7

Cable length: 5 m

Installation position: should be between the wheels. Refer to Figure 8 for the orientation and mounting dimensions (35° in the direction of travel or opposite).



Figure 7

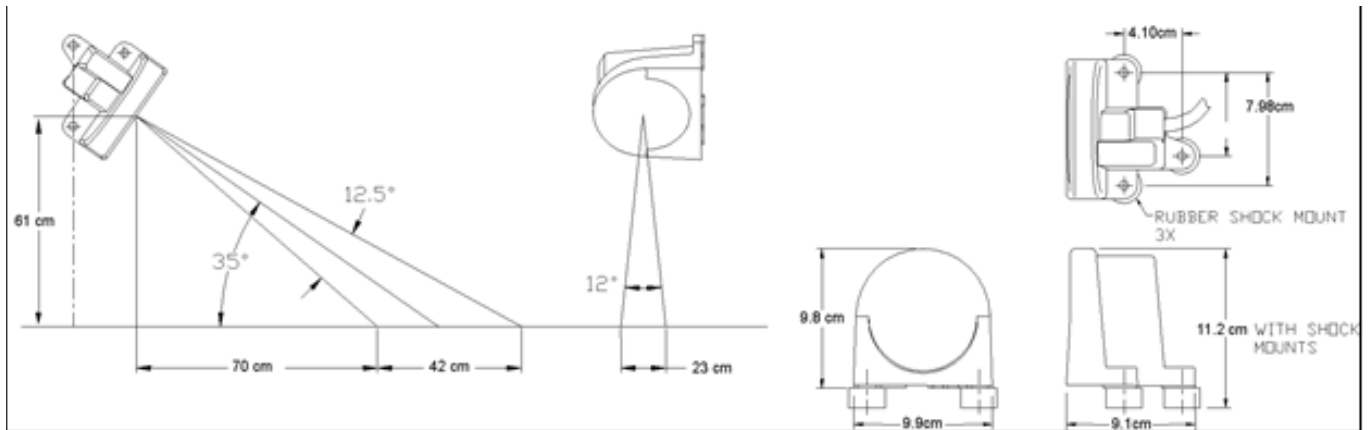

Figure 8

Installation: To fasten the radar sensor, please use the bolts, nuts, and holding plate provided for this purpose in the scope of delivery (see Figure 9)

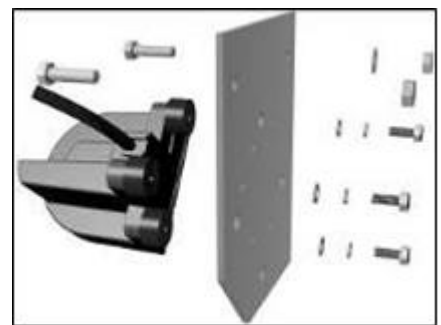

Figure 9

9.4 ACCESSORIES KIT FOR INDUCTIVE WHEEL SENSOR MX

The wheel sensor measures the forward speed [km/h]. This is displayed on the control box and the seed quantity is automatically regulated by regulating the speed of the seeding shaft. As a result, the desired seed quantity per hectare is always maintained, even if the driven speed deviates slightly from the speed defined by the calibration test.

The sensor can detect both the supplied magnets and any type of metal (bolt heads, wheel bolts, etc.).

Order number: 00410-2-181
 Connection: 12-pin plug on the control box
 Settings: see chapter 8.5
 Cable length: 5 m

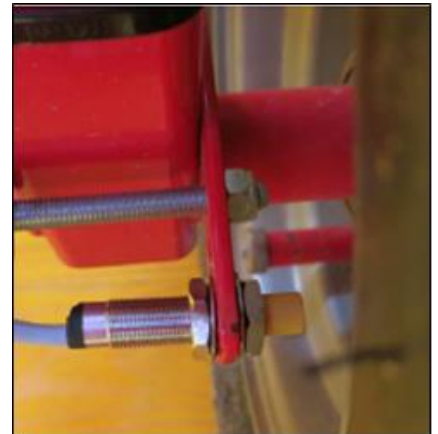

Figure 10

CAUTION!

Do not hold the Neodym magnets close to your heart! If you have a pacemaker, it can cause disturbances!

Installation position: The magnet is installed on the inside of the rim. The sensor must be fastened at a distance of **max. 5 mm** from the magnets (or wheel bolts, nuts, etc.). When the sensor is actuated, the LED on the rear lights up.

Number of magnets:

Wheel diameter [mm]	250	500	1000	1500	2000
Number of magnets [pcs.]	1	2	4	6	8

Installation information:

- For the optimal alignment of 6 magnets, it is best to use a compass (e.g. a string) to form an even hexagon.
- The magnet does not need to be bolted on. It is attached to steel rims through its high magnetic force.
- Route the cable through a well-protected area to avoid any damage (e.g. from the wheel).
- Do not install the wheel sensor on the cardan shaft because its rotational speed is too high and this may cause errors!
- There may not be more than 15 pulses/m.

Scope of delivery: 1 sensor and 2 fastening nuts, 8 Neodym magnets (very strong), cable ties, 1 fastening plate

9.5 ACCESSORIES KIT FOR LINKAGE SENSOR CHASSIS MX

Through this sensor, the seeding shaft of the implement can start and stop rotating automatically when lifting and lowering the implement.

Order number: 00410-2-173
Connection: 12-pin plug on the control box
Settings: see chapters 8.8 and 8.9
Cable length: 5 m



Figure 11

Installation position: Since most soil tillage implements are lifted and lowered during their operation, installing the sensor on the tractor's lifting arm is the best method (see Figure 11). However, the sensor can also be attached at other positions that have a mechanical movement of more than 50 mm. The distance between the sensor and the magnet should be approx. 5 mm. For semi-mounted soil tillage implements, the sensor can be installed on the chassis, because the linkage is not used in this case. The programming (position in which work is performed) can be adapted for this purpose.



NOTE!
The sensor must not be bolted on too strongly (tension)!

Scope of delivery: 1 sensor, 2 magnets incl. bolts, cable ties,
1 fastening plate, 2 PVC nuts for the sensor

9.6 ACCESSORIES KIT FOR LINKAGE SENSOR TOP LINK MX

Through this sensor, the seeding shaft of the implement can start and stop rotating automatically when lifting and lowering the implement.

Order number: 00410-2-169
Connection: 12-pin plug on the control box
Settings: see chapters 8.8 and 8.9
Cable length: 3 m

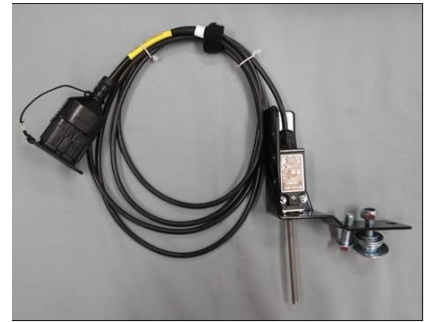

Figure 12

Installation position: Since most soil tillage implements are lifted and lowered during their operation, installing this sensor on the implement's three-point linkage is the best method. However, the sensor can also be attached at other positions that have mechanical movement. The programming (position in which work is performed) can be adapted for this purpose.



Figure 13

9.7 ACCESSORIES KIT FOR LINKAGE SENSOR PULL SWITCH MX

Through this sensor, the seeding shaft of the implement can start and stop rotating automatically when lifting and lowering the implement.

Order number: 00410-2-174
Connection: 12-pin plug on the control box
Settings: see chapters 8.8 and 8.9
Cable length: 5 m
Scope of delivery: 1 sensor, 1 fastening plate incl. fastening bolts



Figure 14

Installation position: Via a spring (for length compensation) and a chain, two points – which move relative to each other when lifting the implement – can be connected. The switch is activated by the change in length and switches off the seeding shaft. The pull switch can be installed on the three-point and can be tensioned with the chain, e.g. on the towing hitch on the tractor. Now if the implement is lifted out, the distance between the two points increases and the pull switch switches off the seeding shaft. However, the switch can also be installed parallel to cylinders in the parallelograms, where a relative movement between the two points takes place during the lift-out procedure. In the programming you can specify whether seeding should occur with the switch activated or not activated.

9.8 SPLITTER SENSOR MX FOR POWER SOCKET

Is required if you want to work with 2 sensors (e.g. the wheel sensor and the linkage sensor).

Order number: 00410-2-153
Cable length: 1 m
Connection: 12-pin plug on the control box



Figure 15

Connection diagram:

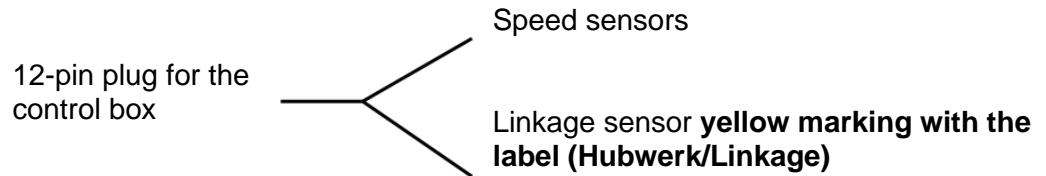

9.9 COMPLETE CABLE SET

For the power supply to the control box without a standard 3-pin standard socket on the tractor, a retrofit kit is available as an accessory. On the battery side, this 8 m cable is bolted directly on the battery terminals. On the other side, a 3-pin standard socket is installed.

Order number: 00410-2-022
Cable length: 8 m

Connection diagram:

Red (6 mm² cable) = 12 volt
Red (2.5 mm² cable) = Ignition plus
Black (6 mm² cable) = Earth



Figure 16

9.10 CALIBRATION BUTTON (CALIBRATION SWITCH)

The calibration button is installed directly in the cable harness of the implement and is simply mounted on the implement with the integrated magnets. This allows you to start the calibration test when you are standing beside the implement, to calibrate for any length of time, and also to empty the hopper. As soon as the calibration test was started on the control box and you actuate the calibration button, the seeding shaft starts rotating. The calibration procedure keeps running until you let go of the calibration button again. The controller then calculates the required spread rate, which then only has to be weighed and entered in the menu.



Figure 17

To achieve sufficient accuracy, the calibration button must be pressed and held for at least 20 seconds; otherwise, the notification message "Calibration time too short!" appears and the kg/ha or grains/m² are not shown on the main display.

Order number: 00410-2-185
Cable length: 1 m
Settings: see chapter 8.13



Figure 18: Installation example

10 INDEX

Abbreviations.....	8	Linkage sensor	19, 29
Accessories.....	31	Linkage sensor pull switch	35
Application rate.....	11, 12, 13, 14, 15, 17	Main display.....	9
Arrow buttons	7	Maintenance and servicing work.....	4
Blower fan settings	21	Motor	19, 24, 25, 30
Buzzer.....	30	Motor revolutions	9, 17
Cable.....	5, 24, 25	Motor speed.....	25
Cable set.....	36	OK button	7
Calibrating according to the area	16	On/Off button	7
Calibration	11, 18	Operating hours counter	20
Calibration button	16, 36	Operating voltage.....	20, 22, 24
Calibration switch	9, 19, 30, 36	Plug	24, 25
Calibration test	10, 15, 17, 22, 23	Plus/minus buttons.....	7
Calibration time	23	Pre-metering.....	18
Calibration value.....	18	Pressure sensor.....	9
Chassis lifting unit sensor	34	Problem solving	26
Connection	5	Programming	9, 28
Control voltage	22	Radar sensor	29, 32
Controller messages.....	22	Seeding shaft7, 9, 12, 14, 15, 17, 22, 23, 24, 25, 28, 30	
Emptying	19	Seeding shaft speed	22
Errors	24	Selection menu	10
Factory settings.....	31	Serial number	8
Fan.....	8, 19, 21, 24, 25, 28, 30	Service.....	4
Fan button	7	Settings.....	11
Fan monitoring	30	Short circuit.....	26
Fill level sensor.....	22, 26	Signal.....	28, 29
Forward speed	11, 13, 14, 17, 18	Signal cable	31
Function descriptions.....	10	Speed	18, 22, 23
Germination capacity.....	13	Speed sensor.....	17
GPS signal	23	Speed signal	26
GPSa sensor	32	Splitter sensor.....	36
Grains	13	Switch-on message.....	9
Ground wheel.....	28	Thousand grain weight.....	13
Hectare.....	20	Top link lifting unit sensor.....	35
Identification	4	Units of measure.....	8, 22, 30
Implement type.....	8, 28, 30	Warranty	4
Initial operation	5, 8	Warranty activation	5
Instructions.....	22	Warranty cases.....	4
Intended use	4	Wheel sensor	29, 33
Languages	8, 20	Working width	11, 13, 14
Lifting unit signal.....	27, 29		



APV Technische Produkte GmbH
Zentrale: Dallein 62
AT - 3753 Hötzelndorf

Tel.: +43 2913 8001
office@apv.at
www.apv.at

